

Sumlog Sensor	TU00-0752-7307102	02/09	1-4	1

Safety information



- The product was developed, manufactured and inspected according to the basic safety requirements of EC Guidelines and state-of-the-art technology.
- The unit is designed for use in grounded vehicles and machines as well as in nautical sports, including non-classified commercial shipping.
- Use our product only as intended. Use of the product for reasons other than its intended use may lead to personal injury, property damage or environmental damage. Before installation, check the vehicle documentation for vehicle type and any possible special features!
- Use the assembly plan to learn the location of the fuel/hydraulic/ compressed air and electrical lines!
- Note possible modification to the vehicle, which must be considered during installation!
- To prevent personal injury, property damage or environmental damage, basic knowledge of motor vehicle/shipbuilding electronics and mechanics is required.
- Make sure that the engine cannot start unintentionally during installation!
- Modifications or manipulations to the VDO product can affect safety. Consequently, you may not modify or manipulate the product!
- When removing/installing seats, covers, etc., ensure that lines are not damaged and plug-in connections are not loosened!
- Note all data from other installed units with volatile electronic

Safety during installation:

- During installation, ensure that the product's components do not affect or limit vehicle functions. Avoid damaging these components!
- Only install undamaged parts in a vehicle!
- During installation, ensure that the product does not impair the field of vision and that it cannot impact the driver's or passenger's head!
- A specialized technician should install the product. If you install the product yourself, wear appropriate work clothing. Do not wear loose clothing, as it may get caught in moving parts. Protect long hair with a hair net.
- When working on the on-board electronics, do not wear metallic or conductive jewelry such as necklaces, bracelets, rings, etc.
- If work on a running engine is required, exercise extreme caution. Wear only appropriate work clothing as you are at risk of personal injury, resulting from being crushed or burned.
- Before taking any action, disconnect the negative terminal on the battery, otherwise you risk a short circuit. If the vehicle is supplied by auxiliary batteries, you must also disconnect the negative terminals on these batteries! Short circuits can cause fires, battery explosions and damages to other electronic systems. Please note that when you disconnect the battery, all volatile electronic memories lose their input values and must be reprogrammed.
- If working on gasoline boat motors, let the motor compartment fan run before beginning work.
- Pay attention to how lines and cable harnesses are laid so that you do not drill or saw through them!
- Do not choose to install the product in the mechanical and electrical airbag area!
- Do not drill holes or ports in load-bearing or stabilizing stays or tie bars!
- When working underneath the vehicle, secure it according to the specifications from the vehicle manufacturer.
- Note the necessary clearance behind the drill hole or port at the installation location. Required mounting depth: 65 mm.
- Drill small ports; enlarge and complete them, if necessary using taper milling tools, saber saw, keyhole saw or file. Deburr edges. Follow the safety instructions of the tool manufacturer.
- Use only insulated tools, if work is necessary on live parts.
- Use only the multimeter or diode test lamps provided, to measure voltages and currents in the vehicle/machine or ship. Use of conventional test lamps can cause damage to control units or other electronic systems.

No Smoking! No open fire or lights!

- The electrical indicator outputs and cables connected to them must be protected from direct contact and damage. The cables in use must have sufficient insulation and electric strength and the contact points must be safe from touch.
- Use appropriate measures to also protect the electrically conductive parts on the connected consumer from direct contact. Laying metallic, uninsulated cables and contacts is prohibited.

Safety after installation:

- Connect the ground cable tightly to the negative terminal of the battery.
- Reenter/reprogram the volatile electronic memory values.
- Check all functions.
- Use only clean water to clean the components. Note the Ingress Protection (IP) ratings (IEC 60529).

Electrical connection:

- Note cable cross-sectional area!
- Reducing the cable cross-sectional area leads to higher current density, which can cause the cable cross-sectional area in question to heat up!
- When installing electrical cable, use the provided cable ducts and harnesses, however, do not run cables parallel to ignition cables or to cables that lead to large electricity consumers.
- Fasten cables with cable ties or adhesive tape. Do not run cables over moving parts. Do not attach cables to the steering column!
- Ensure that cables are not subject to tensile, compressive or shearing forces.
- If cables are run through drill holes, protect them using rubber sleeves or the like.
- Use only one cable stripper to strip the cable. Adjust the stripper so that stranded wires are not damaged or separated.
- Only use a soft soldering process or commercially available crimp connector to solder new cable connections!
- Only make crimp connections with cable crimping pliers. Follow the safety instructions of the tool manufacturer.
- Insulate exposed stranded wires to prevent short circuits.
- Caution: Risk of short circuit if junctions are faulty or cables are damaged.
- Short circuits in the vehicle network can cause fires, battery explosions and damages to other electronic systems. Consequently, all power supply cable connections must be provided with weldable connectors and be sufficiently insulated.
- Ensure ground connections are sound.
- Faulty connections can cause short circuits. Only connect cables according to the electrical wiring diagram.
- If operating the instrument on power supply units, note that the power supply unit must be stabilized and it must comply with the following standard: DIN EN 61000, Parts 6-1 to 6-4.

Sumlog Sensor	TU00-0752-7307102	02/09	1-4	2

1 Installation of the sending unit

The sending unit must be installed in a turbulence-free zone in the hull. If an echo sounder is installed, the Sumlog sending unit should be installed at the same height and to the side of, or laterally offset to the echosounder. Check for sufficient distance to stanchions, stringers, bulkheads, etc. when drilling the hull.



Do not install the sending unit close to external valves, anodes, etc. to avoid influences by turbulence.

2 Installation on sailing boats:

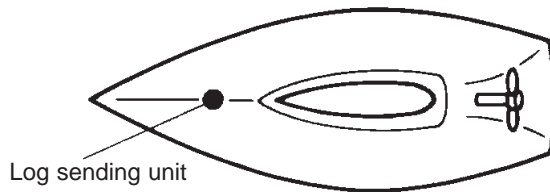

On sailing boats the sending unit should always be installed in front of the keel, as close to the longitudinal ship axis as possible. On boats with a long keel the installation should be at the end of the first third of the hull, but not at the widest location of the hull.

Installation on powerboats:

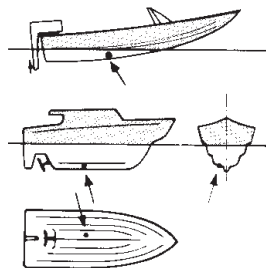
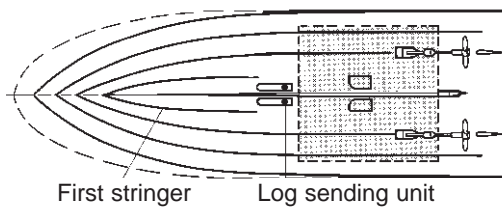

On powerboats the sending unit should be installed at about the first third of the hull and never towards the stern in a zone of strong turbulence or up front, where strong disturbances by air induction must be expected. An ideal installation is near the longitudinal axis of the ship and in the zone of the first stringer, directly in front of the engine compartment if possible. At higher speeds this is the only location where a disturbancefree operation can be expected..

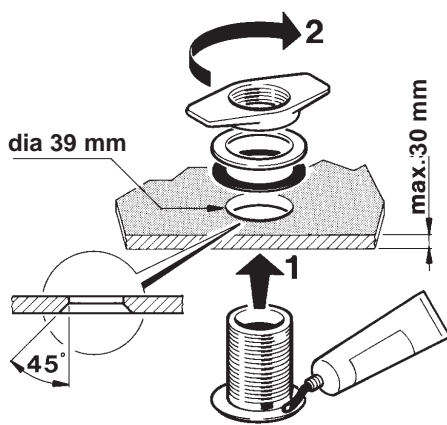

Make a hole 39 mm dia., at a suitable location. The wall thickness can be up to 30 mm. Camber the hole out at 45 degrees for good sealant distribution during the assembly. To install the hull sleeve and the sending unit proceed as follows:

1. Put salt-water resistant sealant on the hull sleeve flange and introduce the sleeve from the outside into the hole.
2. From the inside, install the black sealing ring on the hull sleeve, then the white one, and screw the fixation nut down. Lightly hand-tighten the fixation nut at first. After letting the sealant harden, tighten the nut another 1/4 turn by hand and check the hull feedthrough for leaks.
3. Put the loop of the control rope around the hull sleeve and knot the loose end of the rope to the blind plug.
4. Screw the flood valve to the hull sleeve until an audible click indicates secure seating, is heard.
5. Insert the sending unit from the top and secure it with the nut.

Install flooding valve and sending unit:

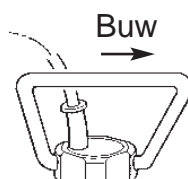
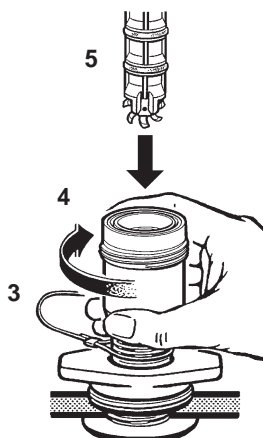

Note the correct direction when inserting the sending unit. The pointed side of the sending unit loop must be directed towards the bow as soon as the sending unit has been inserted.

Sumlog Sensor	TU00-0752-7307102	02/09	1-4	3

3 Removal of the sending unit

Loosen the union nut and pull the sending unit from the sleeve by rotating it slightly. Immediately insert the blind plug.



Never pull on the cable to remove the sending unit. Always use the loop.
Always insert the blind plug when the sending unit has been removed

4 Replacement of the paddle wheel

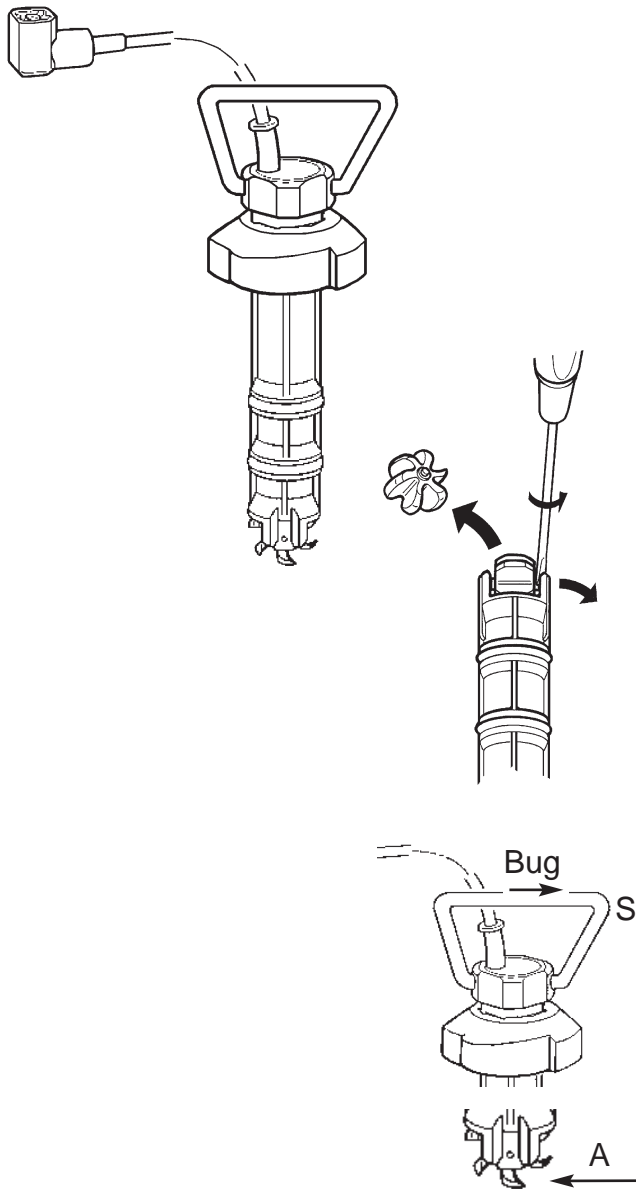

The paddle wheel of the sending unit is rotated by the flow of water. The rotational speed of the paddle wheel is measured without contacts, and transmitted to the indicating instrument.

Use a screwdriver to replace the paddle wheel and its shaft.
Carefully lift the paddle wheel shaft upwards to remove it from the sending unit.
Insert the new shaft into the new paddle wheel and install shaft and wheel, again using the screwdriver.

Check the correct installation direction when replacing the paddle wheel. The spoon-shaped leading surface of the wheel (A) must be directed towards the pointed side of the loop (S).

The pointed side of the loop must be directed to the bow when the sending unit is inserted in the hull sleeve.

Paddle wheel for indicating range 12 (kn, km/h, mph)



Paddle wheel for indicating range 30 and 50 (kn, km/h, mph)



Sumlog Sensor	TU00-0752-7307102	02/09	1-4	4

5 Connection to Viewline Sumlog

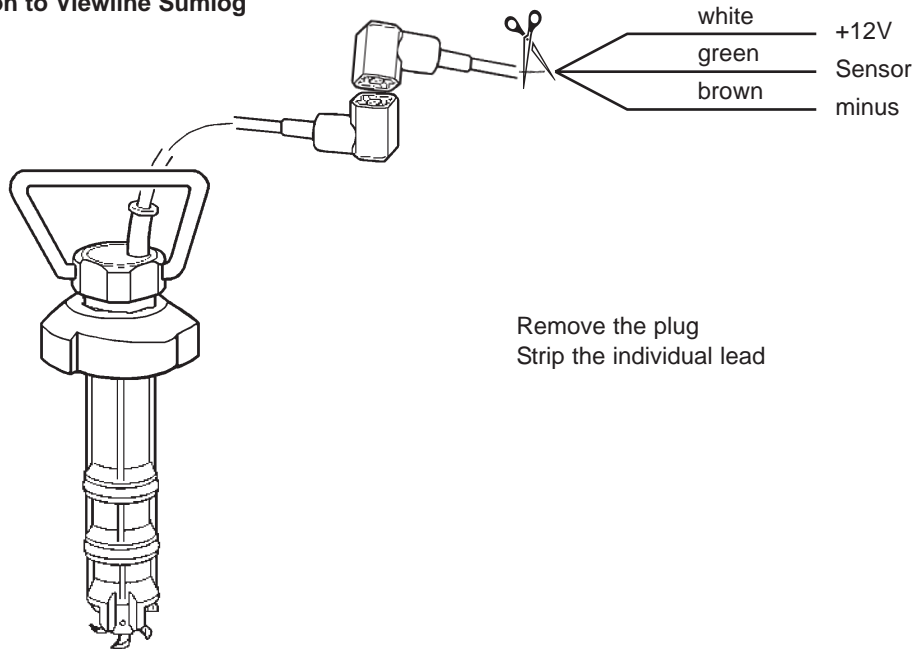

5 Calibration

After installation of the system your Viewline Sumlog must be calibrated to obtain speed and distance measurements with the maximum accuracy.

On the Viewline Sumlog display, select the **FREQUE** setting for the die **INPUT** function.

On the Viewline display, depending on the impeller being used, set the **PULSE** value to one of the following pulse numbers:

- 12 kn: 54737 Imp/nm
- 50 kn: 41748 Imp/nm
- 60 mph: 41748 Imp/nm

Mark two distinct points on the map. The distance between these two points defines the measuring length. During the trip from one point to the other, the Viewline Sumlog measures the covered distance. In flowing waters it is necessary to make the measuring run in both directions to compensate for the influence of the current.

Measuring length:

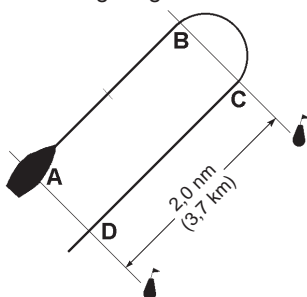

Make a measuring run at a cruising speed, which remains as constant as possible. Check that the trip distance counter is set to zero.

The following example refers to a measuring run in water without a current with a measuring length of 2 nautical miles (nm).

Approach starting point A of the measuring length.

Set the trip distance counter to zero when passing starting point A. **T 00**

Follow the measuring length on a straight line and note the indicated value (1.7 nm in this example) when passing end point B. **T 1.7**

Calculate the calibration factor C with the following formula:

$$C = \frac{\text{Effectively covered distance (A-B)}}{\text{Indication of the display (A-B)}} = \frac{2,0 \text{ nm}}{1,7 \text{ nm}} = 1,18$$

Multiply the calculated value C by the pulse number set on the Viewline display and set the calculated result as the new pulse number.

In the case of a measuring run in flowing water repeat the same distance measuring steps in the opposite direction (measuring length C-D).

The calibration factor is calculated with the following formula:

$$C = \frac{\text{Effectively covered distance (A-B) + (C-D)}}{\text{Indication of the display (A-B) + (C-D)}}$$



Do not use the GPS navigator as a reference for Viewline Sumlog calibration. The GPS Navigator indicates speed over ground (SOG), but the Viewline Sumlog measures speed through water.